

Features & benefits

- Enabling sharp, vertical or horizontal turns
- For installation into walls, floors and ceilings
- For circular AE48C ductwork (DN90/75 mm)
- Anti-static and anti-bacterial properties
- Part of the TÜV SÜD certified Air Excellent system



The 90° bend

The 90° bend is developed to make sharp turns to get around obstacles with a minimum of air resistance. The AE48C duct is developed to lay out with a certain inclination but there will come circumstances where sharp 90° bends are required.

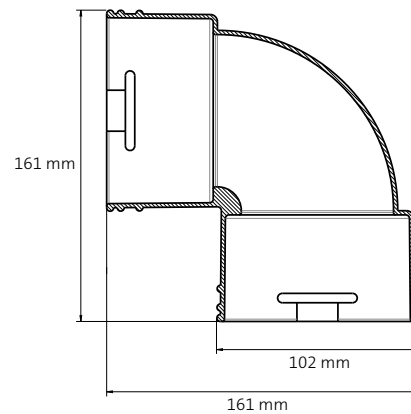

AE48C 90° bend	
Zeta [-]	0.90
Qv [m³/h]	ΔP [Pa]
10	1.0
20	1.0
30	2.0
40	3.3
50	5.0
60	6.9

